

Modicon Quantum to Modicon M340 or M580

Upgrading your control system is easier than you think.

Challenges you may be facing:

- Risk of unexpected downtime due to aging equipment
- Multiple PLC platforms and programming software packages to support
- Preserving the investment in your existing system during an upgrade
- Reduction in skills and/or staff at your plant
- Limited scheduled downtime during upgrades

Benefits of upgrading to M340/M580 (X80 I/O):



- Minimum downtime and risk to upgrade — do it during planned maintenance
- Retain prior investment in software and field wiring
- Reduce unplanned downtime and enhance cybersecurity
- Productivity benefits from a new, more transparent, future-proof solution
- Supported by Schneider Electric™ global service and execution capabilities

Solutions and services for a smoother modernization:

- Extensive experience with successful Quantum to Modicon™ M340 or M580 upgrades
- Automatic conversion of your Quantum application to EcoStruxure Control Expert (formerly Unity Pro)
- Stepwise upgrades in phases to meet your budget and schedule
- Retain your existing I/O and racks if required
- Quick wiring solutions eliminate the time and risk of rewiring existing I/O

Switch to Modicon M340 or M580

Replace CPU with Modicon M580 and retain application program with a conversion service. Choose the preferred I/O rack and wiring solution — partial, stepwise, or full:

Legacy CPU and I/O	Targeted CPU	Partial: Retain I/O racks and wiring	Stepwise: Change I/O racks, retain wiring	Full: Full replacement
Quantum and Quantum I/O	 Modicon M580  Modicon M340	☑	☑	☑



From
Modicon Quantum



To
Modicon M580



Or
Modicon M340

“This significant achievement of executing on a live production facility on critical equipment such as an essential generator could not have been achieved without the contribution from each one of you. It was well planned, safely.”

Yogish M. Shetty
A/OIM — Head of Operations, Production Manufacturing,
RasGas Company Ltd.

Automated efficiency

Repeatable, reliable processing — our high-quality software converters move you into Modicon M580

984 ladder logic import embedded in EcoStruxure Control Expert (formerly Unity Pro):

	Automatic conversion of Legacy Quantum Applications to EcoStruxure Control Expert (formerly Unity Pro)	☑
--	--	---

Minimal downtime

Typically one hour modernization time per I/O rack

Modernization solutions for Quantum

Software upgrade to EcoStruxure Control Expert (formerly Unity Pro)

Our software converter makes it fast and easy to upgrade your application to the M580 platform:

- Retain the look, feel, and function of your legacy applications
- Build on them by adding programming sections using the latest programming languages, functions, objects, and libraries of EcoStruxure Control Expert (formerly Unity Pro)

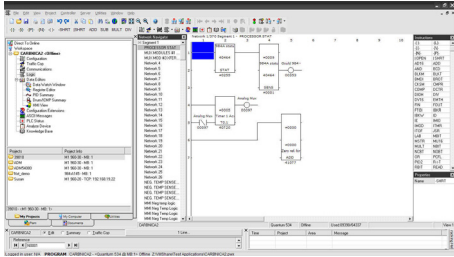

Before conversion

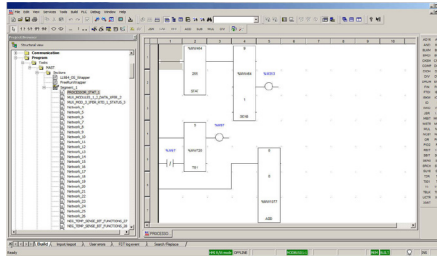

After conversion

Hardware upgrade

Partial PLC upgrade to Modicon M580, retaining legacy I/O racks and wiring:

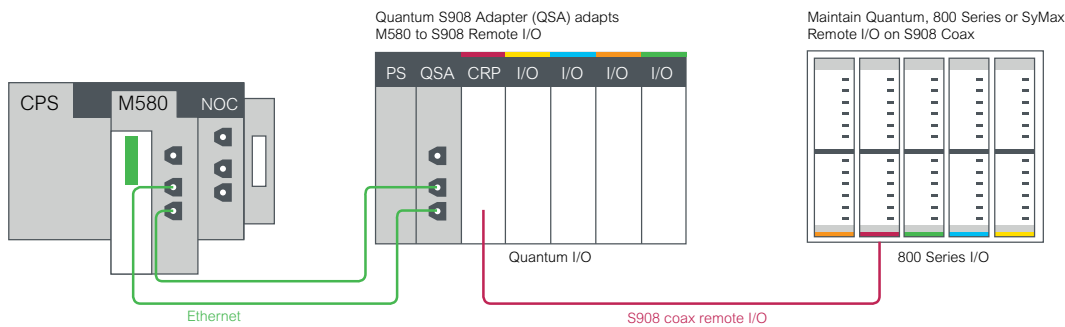

M580 with Quantum S908 adapter (QSA) to retain existing Quantum I/O and S908 network

Ethernet remote I/O and/or S908 to connect to existing I/O racks

Total PLC upgrade to Modicon M580 and new X80 I/O while retaining field wiring:

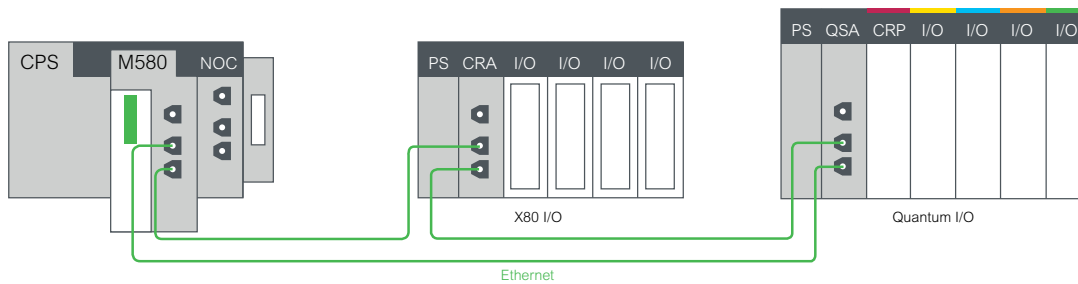

M580 with existing Quantum or X80 Ethernet I/O

Time-saving solutions

Our quick wiring adapters, available soon, will allow you to change out legacy Quantum I/O and keep the original field wiring. Contact your local sales representative for availability.

Benefits

For software

- Retain your prior investment in Quantum PLC programs
- Reduced risk and errors via automated software converter tools
- Reduced time to complete modernization
- Our certified modernization service experts can further refine the converted applications

For hardware

- Retain prior investment in racks and/or I/O field wiring
- Simplified modernization with no rewiring and reduced commissioning time
- Flexibility to upgrade in phases — helps address operational or budget constraints
- Easy to revert to original configuration should production demands dictate

schneider-electric.com/processautomation

Life Is On

Schneider Electric